

# ASSEMBLY AND OPERATIONS SHEET

## ASSEMBLY

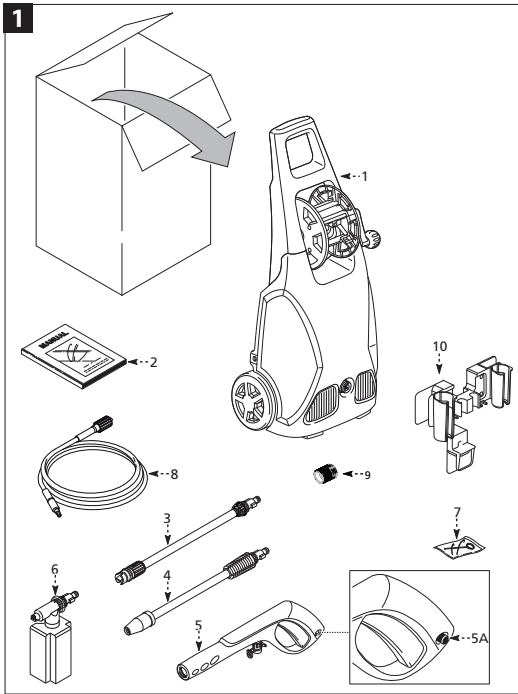

### PACKAGE CONTENT:

1. Pressure Water Unit
2. Manual
3. Adjustable Spray Nozzle
4. Turbo Nozzle
5. Gun
6. Detergent Tank
7. Nozzle Cleaning Tool
8. High Pressure Hose
9. Garden Hose Fitting
10. Accessories Holder
- Gun Safety Button (5A)

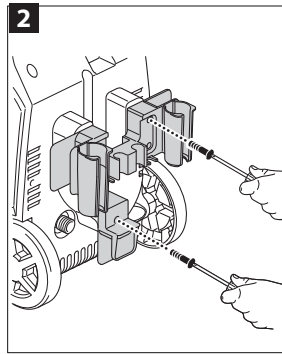

2. Install with supplied screws. Tools needed 1 phillips screwdriver.

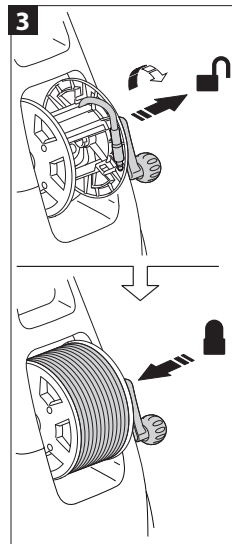

3. Install hose as shown wind and evenly distribute hose. Pull handle to unlock hose reel, press to lock hose reel.

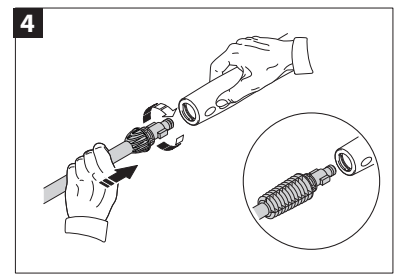

4. Insert lance adapter into the gun push and turn clockwise to positive stop as shown.

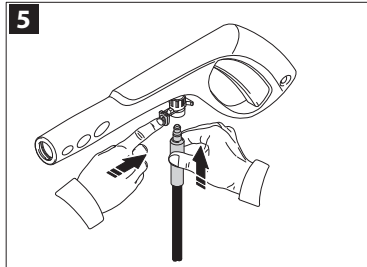

5. Press release button on bottom of gun toward back of the gun, then insert high pressure hose.

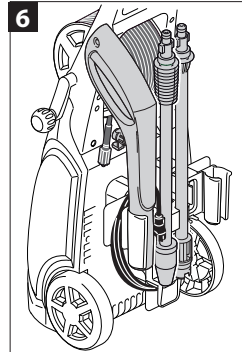

6. Accessories attachment view.

## OPERATIONS

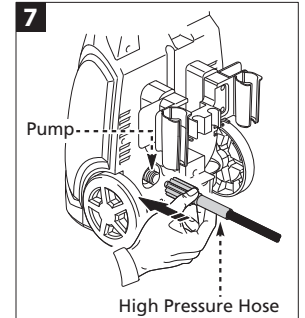

7. Attach the high pressure hose onto the pump water outlet by turning clockwise and hand tightening.

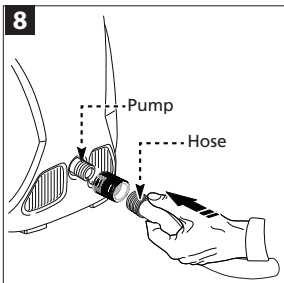

8. a) Attach swivel adapter to pump water inlet, if not already attached. Notice the swivel adapter is marked with the words pump and hose. Make sure to connect pump side of the adapter to the pump water inlet to prevent damage to the threads.

b) Attach garden hose to swivel adapter side marked hose.

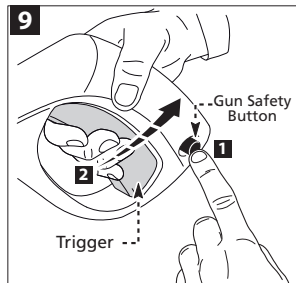

9. Activate the lock by holding the gun and push the lock from left to right. Squeeze trigger to make sure the trigger does not move. The safety trigger lock should be locked at all times when pressure washer is not in use.

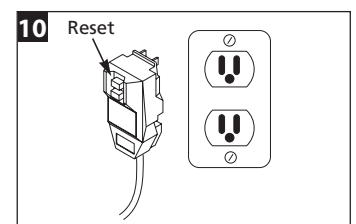

10. a) Plug the power cord into a grounded 120V outlet and press the reset button as shown.

b) THIS MUST BE DONE EACH TIME THE UNIT IS PLUGGED IN AN OUTLET.

## OPERATIONS CONTINUED

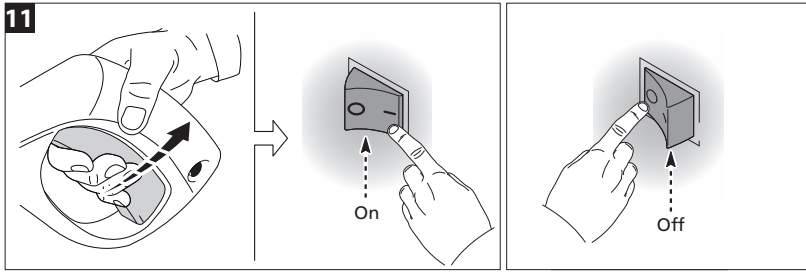

11. a) Pull trigger then turn on power switch.  
b) After turning off power, pull trigger to relieve line pressure before removing spray gun and hose.

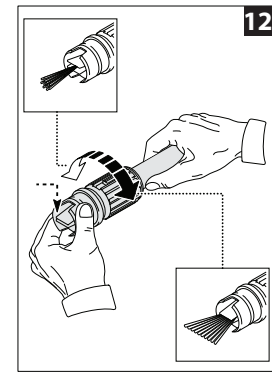

12. Spray pattern shape and intensity can be changed by twisting the spray adjuster at the end of the lance. Keep hands clear of the front of the lance to prevent injury.

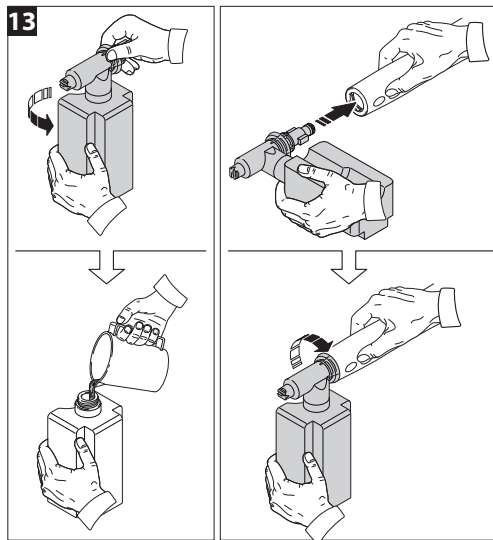

13. The use of detergents can dramatically reduce cleaning time and assist in the removal of difficult stains. Some detergents have been customized for pressure washer use on specific cleaning tasks. These detergents are approximately as thick as water. The use of thicker detergents, such as dish soap, will clog the chemical injection system and prevent the application of the detergent.

The cleaning power of detergents comes from applying them to a surface and giving the chemicals time to break down the dirt and grime. Detergents work best when applied at low pressure.

The combination of chemical action and high pressure rinsing is very effective. On vertical surfaces, apply the detergent starting at the bottom and working your way upward. This will prevent the detergent from sliding down and causing streaks.

High pressure rinsing should also progress from the bottom to top. On particularly tough stains, it may be necessary to use a brush in combination with detergents and high pressure rinsing.

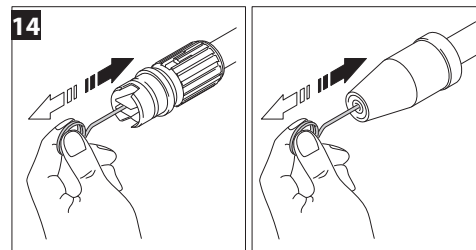

14. Before triggering the gun, adjust the nozzle to a wide fan pattern.
1. Place the nozzle approximately 4 - 5 feet away from the cleaning surface. Then hold the nozzle at a 45° angle to the cleaning surface. Trigger the gun.
  2. Vary the fan pattern spray angle and the distance to the cleaning surface until optimum cleaning efficiency is achieved without damaging the surface.

A clogged or partially clogged nozzle can cause a significant reduction of water coming out of the nozzle and cause the unit to pulsate while spraying.

### TO CLEAN OUT THE NOZZLE:

- Turn off the unit.
- Turn off the water supply. Relieve any pressure trapped in the hose by squeezing the trigger 2 - 3 times.
- Separate lance from gun.
- Rotate nozzle to the narrow stream setting. This opens up the fan blades.
- Using the included tip cleaner, or an un-folded paper clip, insert wire into the nozzle hole and move back and forth until debris is dislodged.
- Remove additional debris by back-flushing water through the nozzle. To do this, remove the lance from the gun, place end of a garden hose (with water running) to tip of nozzle pushing water and debris out the back opening of the lance.